



- + LAN VPN Gateway for Industrial IoT applications
- + Powerful CPU with 1.3 GB storage to host customer SW applications
- + 2x Ethernet 10/100, 1x RS232, 1x RS485 and I/O
- + Optional Wi-Fi 802.11ac using MU-MIMO technology, Bluetooth v5.1 (class 1)
- + Robust metal cover with DIN and Wall mount options
- + Operational temperature range from -40 °C to +75 °C
- + Backup real time clock
- + Sleep mode & Power ignition

The ICR-3201 gateway is the perfect way to connect IP or serial devices to a LAN network via WAN interface. Industrial M2M and IoT applications include kiosks, industrial PCs, HMIs, traffic controllers, meters, UPS systems, and much more.

With upload speeds of up to 100 Mbit/s and download speeds of up to 100 Mbps, the ICR-3201 provides ample bandwidth high data demand applications such as CCTV or public Wi-Fi hotspots.

In addition to its two independent or switched Ethernet ports, serial ports RS232 and RS485, ICR-3201 has built-in digital I/O connectivity, backup real-time clock and sleep mode support. Optional built-in Wi-Fi and Bluetooth v5.1 (class 1) modules are available (ICR-3201W). WiFi with 802.11a,b,g,n,ac modes, and MU-MIMO support is appropriate for Wi-Fi applications.

The router supports VPN tunnel creation using various protocols to ensure safe communications. The router provides diagnostic functions which include automatic monitoring of the wireless and wired connections, automatic restart in case of connection losses, and a hardware watchdog that monitors the router status.



The ICR-3201 places intelligence at the network edge with an extremely powerful Cortex A8 CPU at 1GHz, 512 MB RAM and 4 GB EMMC FLASH memory in pSLC mode for a long-lifetime and critical industrial applications. 1.3 GB of memory space is allocated for customer SW applications and data. With open Linux platform and wide possibilities of programming customer SW applications in Python, C/C++ or browser-based flow editor Node-RED the ICR-3201 offers a real open development platform for Industrial IoT applications.

The Advantech existing app library (User modules) with apps already developed to enhance specific router functionality including industrial protocol conversions and support of IoT platforms such as MS Azure, Cumulocity, ThingWorx and others are supported on the router.

ICR-3201 is easy to install using WebAccess/DMP, a full featured configuration and monitoring tool for mass deployment. The router also supports additional traffic and health monitoring software R-SeeNet.



ORDERING INFORMATION - Antennas & Power Supplies Sold Separately

MODEL NO. - ORDER CODES	REGION	2x ETHERNET	RS232 RS485	I/O	WI-FI 802ac	2x MIMO	Bluetooth v5.1 (class1)
 ICR-3201	Global	✓	✓	✓			
 ICR-3201W	Global	✓	✓	✓	✓	✓	✓

* Check availability of another models for various world regions at our corporate website or with your local distributor.

ICR-3201, ICR-3201W

INDUSTRIAL IoT LAN ROUTER & GATEWAY



ACCESSORIES - INCLUDED

DESCRIPTION	
Wall mount kit	WALL-ICR32
DIN clip	BB-DIN-ICR32
Serial / IO connector	BB-CON-ICR32-10
PWR connector	BB-CON-WR2
Quick Start Guide	

ACCESSORIES - SOLD SEPARATELY

ORDER CODE	DESCRIPTION
BB-AW-A2458G-FSRPK	Antenna Wi-Fi 2.4 & 5.8 GHz
BB-RPS-v2-WR2-AUS	Wall mount Power Supply 12V/1A, AUS plug
BB-RPS-v2-WR2-EU	Wall mount Power Supply 12V/1A, EU plug
BB-RPS-v2-WR2-UK	Wall mount Power Supply 12V/1A, UK plug
BB-RPS-v2-WR2-US	Wall mount Power Supply 12V/1A, US plug

SPECIFICATIONS

NETWORKING	
Network and Routing	DHCP Server, NAT/PAT, VRRP, Dynamic DNS client, DNS proxy, VLAN, QoS, DMVPN, NTP Client/ Server, IGMP, BGP, OSPF, RIP, SMTP, SMTPS, SNMP v1/ v2c/ v3, Backup Routers, PPP, PPPoE, SSL, Port Forwarding, Host Port Routing, Ethernet Bridging, Load Balancing, IPv6 Dual Stack
Security	HTTPS, SSH, VPN tunnels, SFTP, DMZ, Firewall (IP Filtering, MAC address filtering, Inbound and outbound Port filtering)
VPN Tunnelling	Open VPN client and server and P2P, L2TP, PPTP, GRE, EasyVPN, IPSec with IKEv1 and IKEv2
Configuration	Web server, SSH, Four configuration switchable profiles, Automatic configuration update from server, Backup configuration, Restore configuration
Firmware Management	Automatic firmware updates from the server, locally via LAN or remotely via WAN (HTTP, HTTPS)
Diagnostic	One CLICK report - current configuration / factory identification / system log / kernel log / reboot log / routing table, Remote diagnostics possible via SSH
Status	Network Status, DHCP Status, IPSec Status, Statistics history for last 60days
Log	System Log, Reboot Log, Kernel Log
Controlling and Diagnostic	SMS, SNMP v1/v2c/v3, Statuses
Event Engine	StartUp script & Up/Down script (Bash, Python), Digital Input, Network Parameters, Data Usage, Timer, Power, Device Temperature. Report Types: SMS, email, SNMP Trap
Industrial Protocols	Modbus RTU/TCP gateway, IEC 60870-5-101 to 104 gateway, DF1, DNP3
Applications Development	Open Linux, Python, BASH, C/C++, Node-RED

PORTS, LED, ANTENNAS	
2x Ethernet	RJ45, 10/100 Mbps
LED indicators	PWR,USR
2x MIMO WiFi antenna - *optional	R-SMA connector
1x RS232, 1x RS485	(10-Way Terminal block)
I/O	1x Digital Input (On Voltage: 2.7V to 36VDC) 1x Binary Output (10-Way Terminal block)

CPU, MEMORY	
CPU	Cortex-A8, 1000 MHz
RAM	512 MB
Flash memory	eMMC - 4096 MB (838 MB for Router Apps, 512 MB for customer data)

MECHANICAL	
Metal case, Metal DIN rail, Wall mount kit	Metal
Enclosure Dimensions	31.2 x 94 x 129 mm
Weight - ICR-3201	457 g
Weight - ICR-3201W	477 g



SPECIFICATIONS - CONTINUED

POWER, CONSUMPTION, ENVIRONMENTAL, IP COVER

Power Supply	9–36VDC (2-Way Terminal block)
Power Consumption with WiFi - Idle / Average / Peak / Sleep Mode	2.5 / 4 W / 11 W / 10 mW
Temperature Range – Operating / Storage	-40 to +75 °C / -40 to +85 °C
Humidity – Operating / Storage (noncondensing)	0 to 95 % / 0 to 95 %
Cold Start	-40 °C
Operating Altitude	2000 m / 70 kPa
Enclosure Rating	IP30
Grounding screw	

STANDARDS AND REGULATIONS

Radio	EN 301 893, EN 300 328
EMC	EN 301 489-1, EN 301 489-17, AS/NZS CISPR 32, FCC Part 15 Subpart B, ICES-003 Issue 6, EN 61000-6-2
Safety	UL/EN/AS/NZS 62368-1
Climatic	EN 60068-2-1, EN 60068-2-2, EN 60068-2-14, EN 60068-2-30, MIL-STD-810G, SAE J1455
Mechanical	EN 60068-2-27, EN 60068-2-31, EN 60529, MIL-STD-810G, SAE J1455
Transportation	E-Mark E8 homologation number: 10R – 05 10350
National	CE, FCC, IC, RCM compliant
Environmental	REACH, RoHS3 and WEEE compliant

WI-FI *

Antenna Connector	2× R-SMA – 50 Ohms (MU-MIMO)
Supported WiFi Band	2.4 GHz to 2.495, 5.15 GHz to 5.825 GHz
Standards	IEEE 802.11ac Wave 2, 802.11d, 802.11e, 802.11h, 802.11i
Security - Standards	WEP, WPA, WPA2
Security - Encryption	WEP, TKIP, AES
Security - EAP Types	EAP-FAST, EAP-TLS, EAP-TTLS, PEAP-GTC, PEAP-MSCHAPv2, PEAP-TLS, LEAP
WiFi Standards	802.11a, 802.11b, 802.11g, 802.11n, 802.11ac Wave 2 WPA Enterprise, WPA2 Enterprise
Type of Device	Access point, Station

Bluetooth specifications *

Version	Bluetooth 5.1, class 1
Support data rate	1 Mbps (GFSK), 2 Mbps ($\pi/4$ -DQPSK), 3 Mbps (8-DPSK)
	Bluetooth@SIG Qualification

* Available only in "W" variant of the cellular router.

ICR-3201, ICR-3201W

INDUSTRIAL IoT LTE ROUTER & GATEWAY



MECHANICAL DRAWING

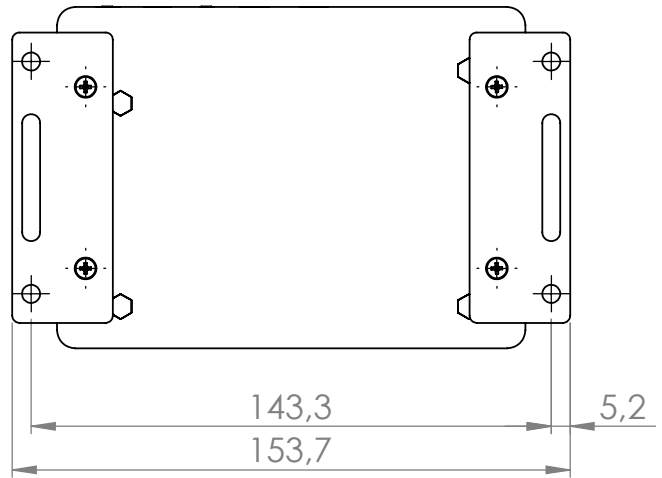
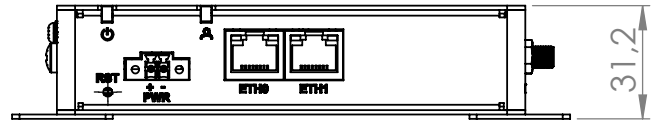
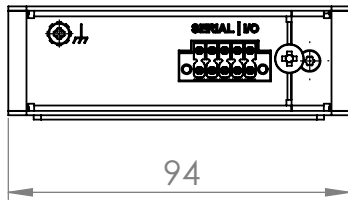

FRONT VIEW

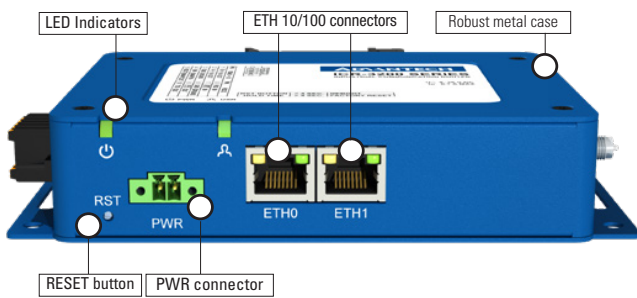

REAR VIEW

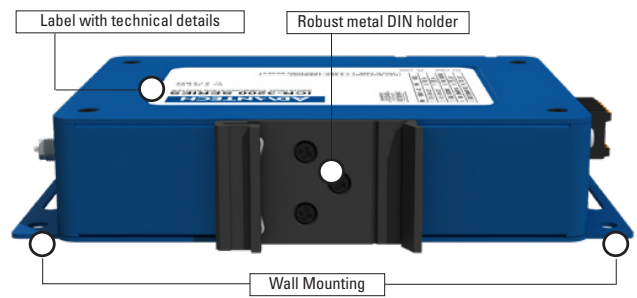

LEFT SIDE VIEW

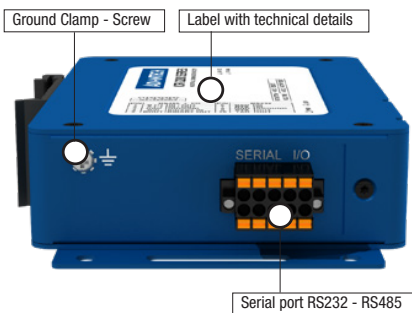

RIGHT SIDE VIEW

